



Fronius Symo Hybrid with external battery

- EN Installations instructions
- EN System monitoring



Contents

Connecting the external battery to the Fronius Symo Hybrid	5
Components.....	5
Fronius Checkbox 500V.....	5
External battery.....	5
Fronius Checkbox 500V technical data	6
Fronius Checkbox 500V status LED	6
Installing the Fronius Symo Hybrid with the external battery	7
Tips before commissioning	7
Commissioning	7
Maximum clearances between the components	7
Modbus cabling and terminating resistors	7
Installing the Fronius Checkbox.....	9
Safety.....	9
Mounting and connecting up the Fronius Checkbox 500V	10
Installing the ferrite ring for the data line.....	10
Installing and configuring Fronius system monitoring	11
Safety.....	11
Using for the first time	11
Information to help you work through the technician wizard	13
Software version of the Fronius system monitoring	14
Updating the firmware via the Web.....	14
Performing a software update on the external battery	15
Fronius system monitoring settings	17
Settings on the Fronius system monitoring website.....	17
Creating IO mapping.....	17
System monitoring settings.....	17
Troubleshooting	18
Troubleshooting	18

Connecting the external battery to the Fronius Symo Hybrid

Components

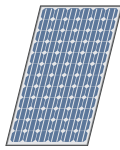

Solar module

Generates direct current



Inverter - Fronius Hybrid inverter

Converts direct current into alternating current and charges the battery. Thanks to the built-in system monitoring function, the inverter can be integrated into a WLAN network.



Fronius Checkbox 500V

Needed to establish a secure connection between the inverter and the battery.



External battery

Connected on the DC side to the Checkbox and the inverter and stores electrical energy.

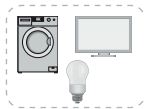

Photovoltaic system consumers

The consumers connected to the PV system (single or three-phase)

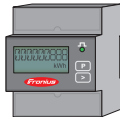

Meter - Fronius Smart Meter

For optimum energy management. The meter can be installed in the switch cabinet by your electrical engineer.



Grid

Fronius Check-box 500V

The Fronius Checkbox 500V connects the Fronius Symo Hybrid to an external battery. The inverter and battery must never be directly connected to each other, as an error could lead to surges that place the system in an unsafe state.

There are separate Installation Instructions for the battery and the Fronius Symo Hybrid. This document is concerned only with the specifics of establishing a connection to the Fronius Checkbox 500V. The remaining steps for installing the equipment can be found in the respective Installation Instructions. All Fronius documents are available at the following address: www.fronius.com/energy-package-manuals

External battery

Fronius points out that the external batteries are not Fronius products. Moreover, Fronius is not the distributor of these batteries. Therefore, Fronius does not assume any liability or guarantee for these batteries.

**Fronius Check-
box 500V techni-
cal data**

Environmental conditions		
Degree of protection	IP65	
Permissible ambient temperature	-25 °C - +60 °C	
Maximum altitude	2000 m	
Permitted humidity	0 - 100% (non-condensing)	
Electrical specifications		
Maximum input voltage		
Inverter side	Udc max in_INV	1000 V
Battery side	Udc max out_BAT	500 V
Maximum current	Idc max in / max out	16 A
Self-consumption	@ 450 V	1.9 W
Dimensions and weight		
Dimensions h x w x d (without packaging)	26 x 19 x 7.5 cm	
Weight (without packaging)	1.4 kg	
Dimensions h x w x d (with packaging)	36 x 30 x 13 cm	
Weight (with packaging)	1.9 kg	
Standards and directives		
Applicable standards and directives	LVD (2014/53/EU), IEC 62109-1	

**Fronius Check-
box 500V status
LED**



When the status LED lights up green, an electrical connection has been established between the inverter and the battery.

Installing the Fronius Symo Hybrid with the external battery

Tips before commissioning

It can take up to two hours to update the inverter. During this time the inverter must be connected to an AC power source. To save time during installation, work may still be carried out in a non-live area of the system while the update is in progress. More information on the update process can be found under "Software version of the Fronius system monitoring" on page 14

Commissioning

IMPORTANT! Failure to follow these steps in the correct order will not only invalidate the warranty, but also risks a deep discharge of the battery.

IMPORTANT! If the installation cannot be completed in one attempt, precautions must be taken to prevent a deep discharge of the battery (see the battery Installation Instructions).

Observe the enclosed complete circuit diagram for the entire system during commissioning.

Set up the entire system in the following order:

1. Install the inverter (Fronius Hybrid series)
2. Install the Fronius Smart Meter
3. Install the Fronius Checkbox and external battery
(for more information on installing the Fronius Checkbox, see section Installing the Fronius Checkbox on page 9)
4. Launch and complete the Setup wizard (wizard on the inverter)
5. Configure communication between the battery and the inverter
6. Carry out a function test

Maximum clearances between the components

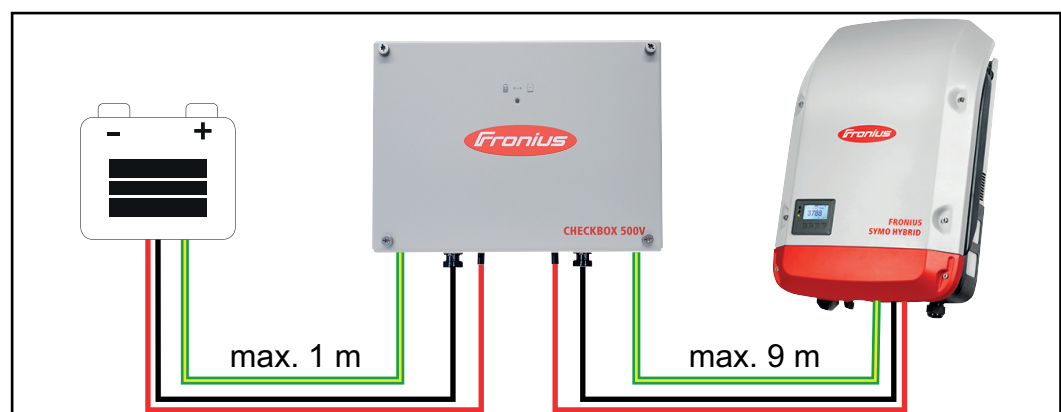

Modbus cabling and terminating resistors

A terminating resistor must be used on the outer components of the Modbus cabling. The location of the terminating resistor on the external battery is fixed, meaning that the battery cannot be installed in the middle of the Modbus.

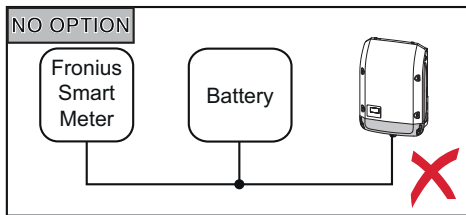
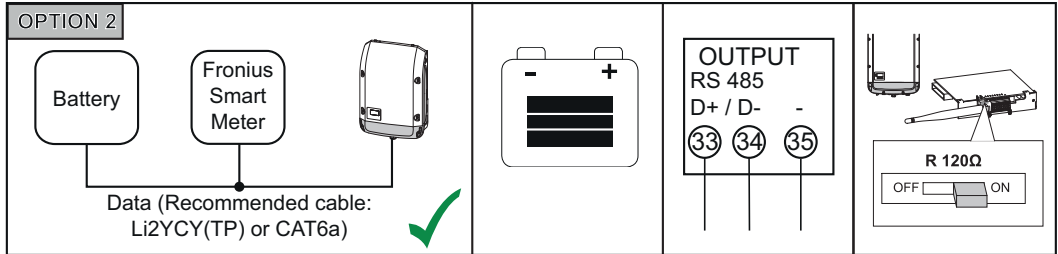
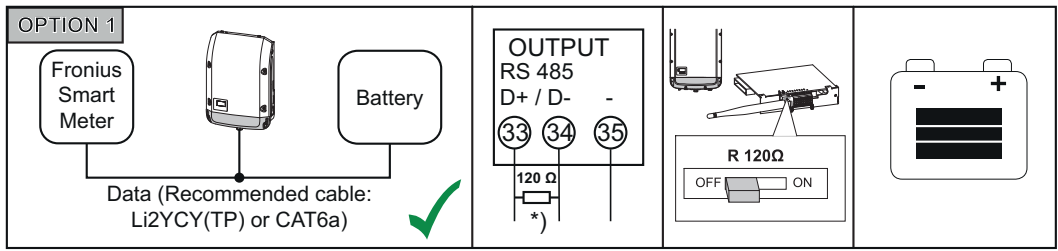

*) The R 120 Ohm terminating resistor is supplied with the Fronius Smart Meter

Installing the Fronius Checkbox

Safety

WARNING! Operating the equipment incorrectly or poor workmanship can cause serious injury or damage. Commissioning of the hybrid system may only be carried out by trained personnel in accordance with the technical regulations. Read the Installation Instructions and the Operating Instructions of the Fronius Symo Hybrid and the battery before carrying out any installation or commissioning work.

WARNING! An electric shock can be fatal. Danger due to DC voltage from the inverter and the battery.

- Always make sure the inverter is disconnected and de-energised before carrying out any connection work.
- Check that the battery is de-energised. The battery should be de-energised when it is delivered.
- Only an authorised electrical engineer is permitted to connect this equipment to the public grid.

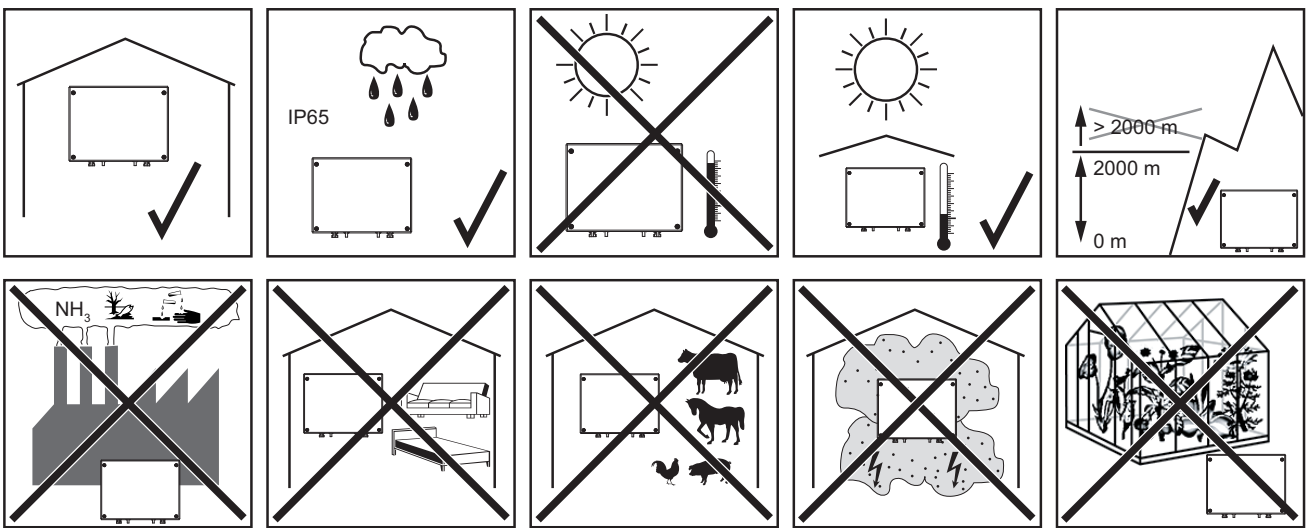

Possible assembly positions when using outdoors:

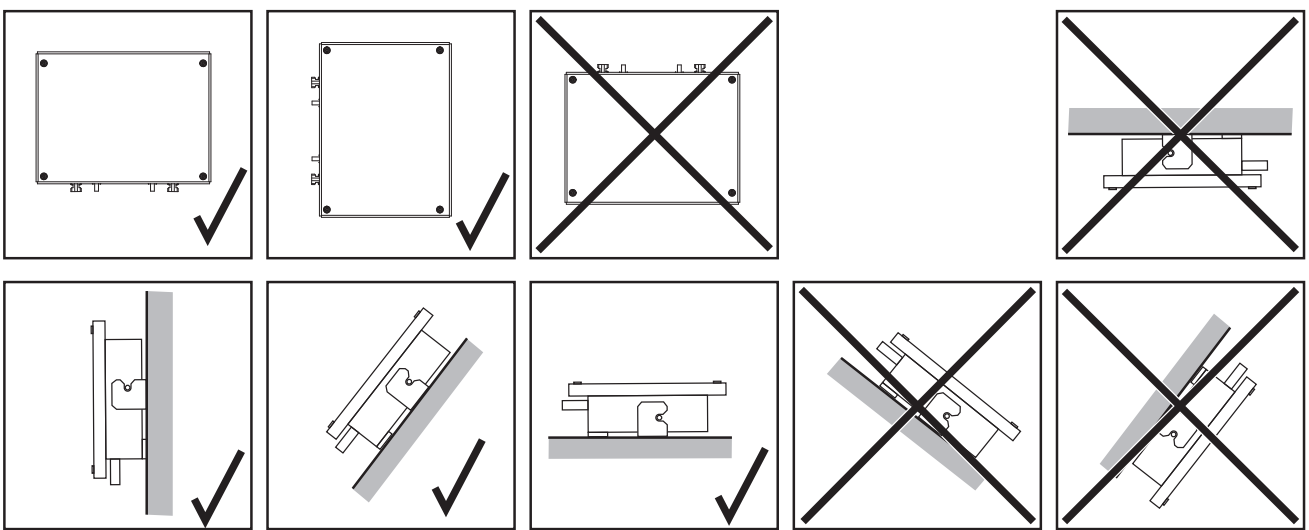

Mounting and connecting up the Fronius Checkbox 500V



NOTE! Risk of damage to the device. Do not mix up the DC connections of the battery and the inverter.

Observe the enclosed complete circuit diagram when connecting up the Fronius checkbox.

- 1 Mount the supplied mounting bracket to the wall using suitable screws and wall plugs
- 2 Attach the Fronius Checkbox, push it down, and secure using the screw supplied

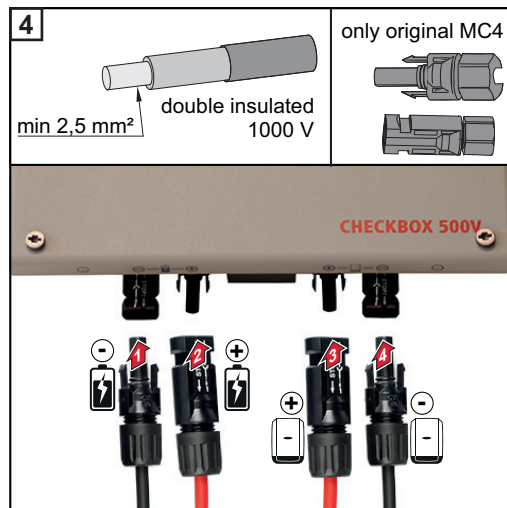
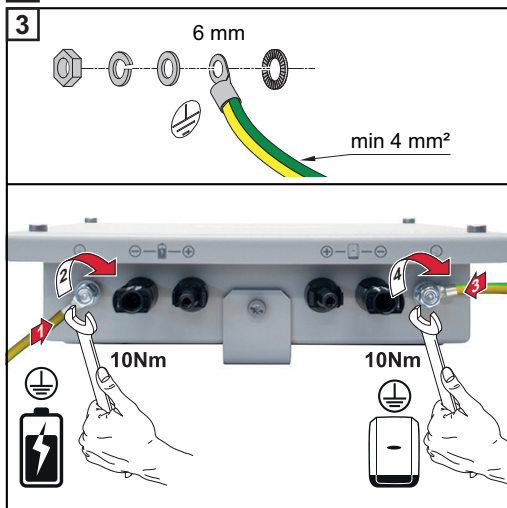

Installing the ferrite ring for the data line

The data line between the inverter and the battery must be fitted with a ferrite ring as close as possible to each of the two terminal connections in order to avoid electromagnetic interference.

One ferrite ring is supplied with the Fronius Symo Hybrid and one is supplied with the Fronius Checkbox (Würth ferrite ring - item number: 74271132S).

- 1 Fit a ferrite core to the data line ahead of the terminal connection in the inverter
- 2 Remove the insulation from the data line ahead of the battery terminal connection and loop the line through the ferrite core twice

Installing and configuring Fronius system monitoring

Safety

 **WARNING!** Operating the equipment incorrectly can cause serious injury and damage. Do not use the functions described until you have thoroughly read and understood the following documents:

- these operating instructions
- all the operating instructions for the system components, especially the safety rules

 **NOTE!** Knowledge of networking systems is required in order to install Fronius system monitoring.

Using for the first time

 **NOTE!** The Fronius Solar.web App makes it much easier to set up Fronius system monitoring when using it for the first time. The Fronius Solar.web App is available in the relevant App store.

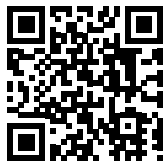

or

„<https://wizard.solarweb.com>visit "<https://wizard.solarweb.com>"

Important! In order to establish a connection to Fronius system monitoring, the end device in question (e.g. laptop, tablet, etc.) must be set up as follows:

- "Obtain IP address automatically (DHCP)" must be activated

- 1 Switch the device to Service mode
 - Activate the WiFi Access Point via the Setup menu on the inverter

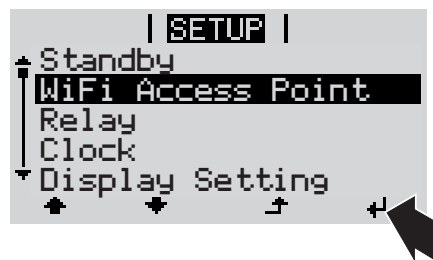

The inverter establishes the WLAN Access Point. The WLAN Access Point remains open for 1 hour.

Installation using the Solar.web App

- 2 Download the Fronius Solar.web App



- 3 Run the Fronius Solar.web App

Installation using a web browser

- 2 Connect the end device to the WLAN access point.

SSID = FRONIUS_239.xxxxx (4 - 8 digits)

- Search for a network with the name "FRONIUS_239.xxxxx"
- Establish a connection to this network
- Enter the password 12345678

(Alternatively, connect the end device and inverter using an Ethernet cable.)

- 3 Enter the following in the browser:
http://datamanager
or
192.168.250.181 (IP address for WLAN connection)
or
169.254.0.180 (IP address for LAN connection)

The Setup wizard start page is displayed.

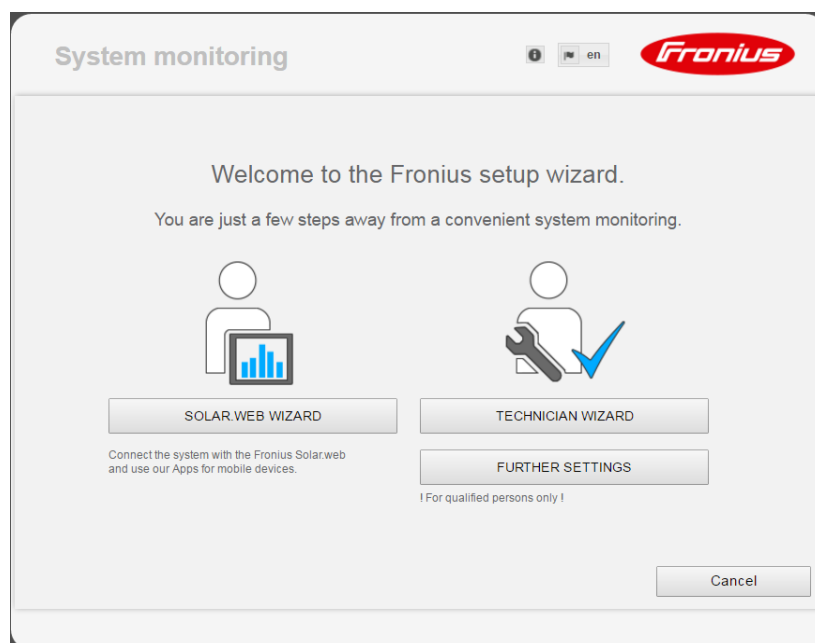

If you run the technician wizard, always remember to make a note of the assigned service password. This service password is required to enter settings in the "System overview" and "DNO Editor" menus as well as "Advanced battery settings".

If the technician wizard is not run, no specifications regarding power reduction are set and hybrid mode is not possible (charging and discharging of the battery)

- 4 Run the technician wizard and follow the instructions

IMPORTANT! The solar web wizard must be run to activate the battery and, where necessary, the Smart Meter. Not activating the battery can lead to deep discharge and this can cause long-term damage to the battery.

- 5 Run the solar web wizard and follow the instructions

The Fronius Solar.web homepage
or
the Fronius system monitoring web page is displayed.

Information to help you work through the technician wizard

The description below only applies to technician wizards for inverters with software version 1.9.x-x or higher. Thus, IO and battery mapping are not possible. Only once the software has been updated (see "Updating the firmware via the Web" on page 14) can the settings be changed in the web interface under "IO mapping" (see "Creating IO mapping" on page 17) and "System overview" (see "System monitoring settings" on page 17).

The technician wizard consists of 5 steps:

1. General

General system data (e.g. system name) is entered here

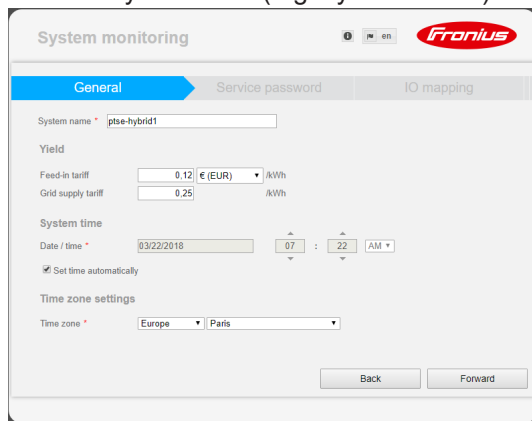

2. Service password

Enter (and make a note of) the service password.

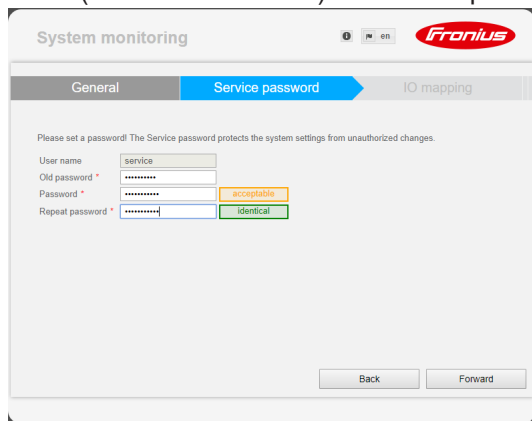

3. IO mapping

Settings for the IO interface are entered (also see Creating IO mapping on page 17)

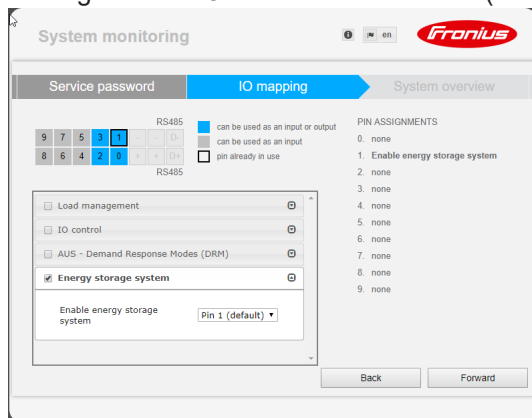

4. System overview

Settings for the entire PV system are entered (see also System monitoring settings on page 17)

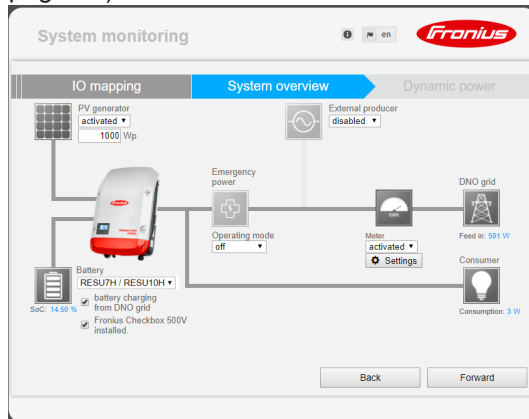

5. Dynamic power

Enter the settings for the dynamic power reduction

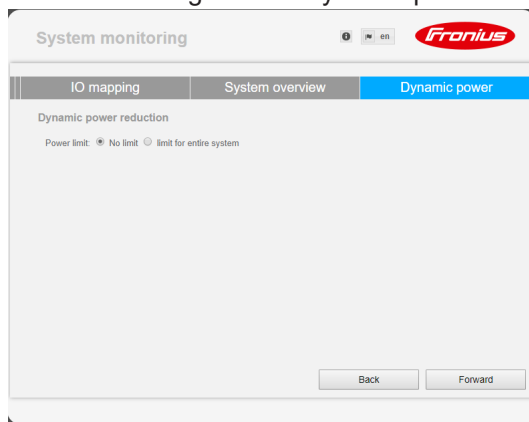

Software version of the Fronius system monitoring

Software version 1.9.x-x or higher is required to support third-party batteries. There must be an internet connection for the duration of the update process. The current version of the system monitoring software can be viewed by clicking on the info symbol:

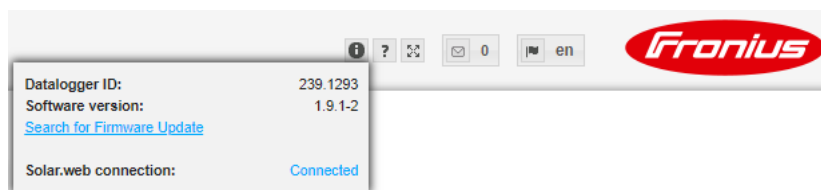

Regardless of the software version shown in the web interface, it may take several update steps before the software is updated to the latest version. Both the inverter and the battery can be updated at the same time.

Updating the firm-ware via the Web

- 1 Use your web browser to open the Fronius system monitoring web page.
- 2 Open "Firmware update" under "Services".
- 3 Select 'Update via Web'
- 4 Click the 'Run update' button.
A confirmation prompt for the update is displayed.
- 5 Click the 'Yes' button

The update is performed and progress is indicated in the form of a bar and as a percentage.

- 6 Once the update has been successfully completed, click on the **Apply/Save** button

If the connection to the server fails:

- Deactivate the firewall for the amount of time required to complete the update.
- Try again.

IMPORTANT! If a proxy server is being used to establish the Internet connection:

- You must activate the "Use proxy server for Web update" option.
- You must enter the data required.

Performing a software update on the external battery

CAUTION! Risk of damage to the battery! Interruptions to the battery software updating process can damage the battery. To avoid this during the update:

- Do not switch off the inverter
- Do not switch off the battery
- A state of charge (SoC) of over 50% is recommended for the battery
- Ensure a steady mains supply
- Ensure and do not interrupt Modbus communication

CAUTION! Risk of damage to the battery! If, despite safety precautions, the updating process is still interrupted, follow the steps for turning off the battery as outlined by the manufacturer of the external battery in the correct order. Then immediately inform your contact at the manufacturer of the external battery to avoid long-term damage. A battery in standby mode can become permanently damaged in just a few days due to self discharge.

As soon as the battery software needs to be updated, a message will appear on the system monitoring website.

- 1 Click the message stating that the battery needs to be updated



- 2 A page will appear with different setting options. Under "Update", select "Local" and click "Run update"

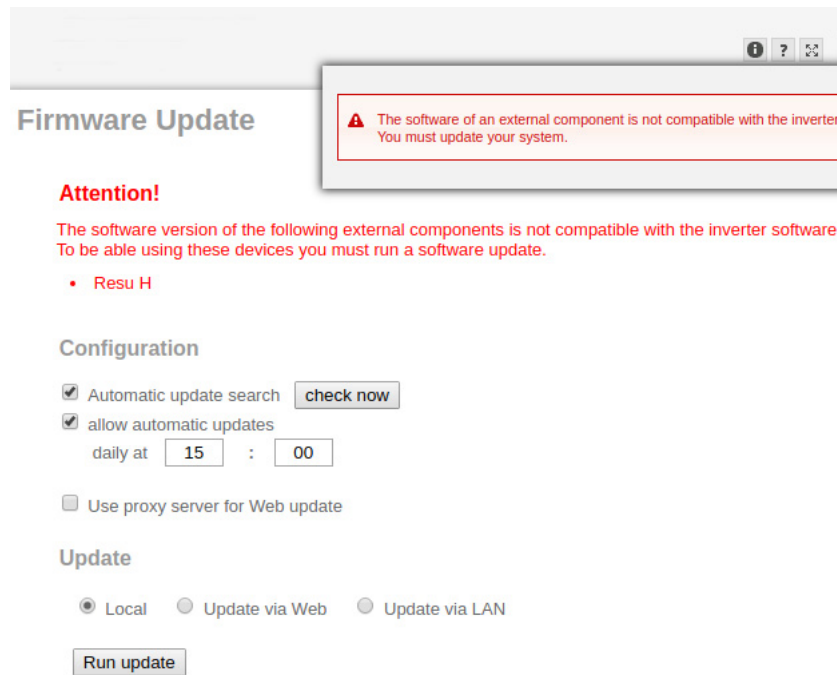

- 3 The update will start and run to completion. This can take up to an hour. Wait until the end of the update.

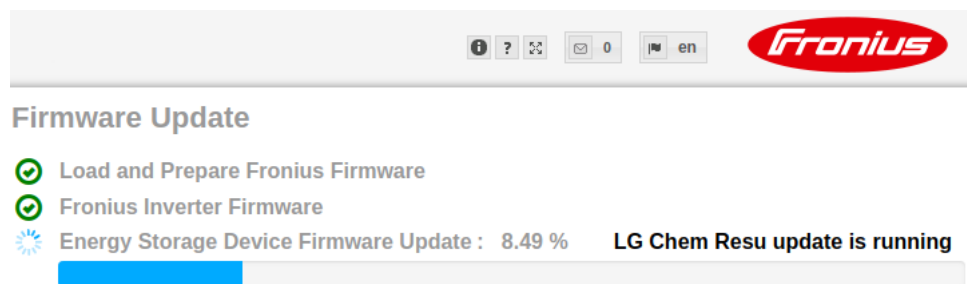

- 4 A message will appear stating that the update was successful. Confirm the message by clicking "OK".

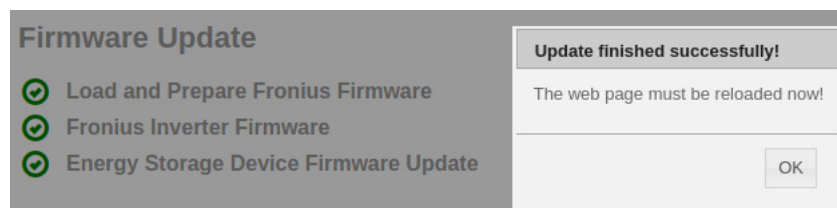

Fronius system monitoring settings

Settings on the Fronius system monitoring website

If the battery is installed at a later date or the inverter was only updated to software version 1.9.x-x after the system had already been commissioned, several settings will need to be changed on the system monitoring website. In the "IO mapping" section, a pin must be selected under "Energy storage system". The battery must be selected in the "System overview" area.

Creating IO mapping

- Under Settings - IO mapping, activate "External storage system". The assigned pin must correspond to the cabling.

9	7	5	3	1	-	-	D-
8	6	4	2	0	+	+	D+

RS485

Load management ⊞
 IO control ⊞
 AUS - Demand Response Modes (DRM) ⊞
 Energy storage system ⊞

Enable energy storage system Pin 1 (default) ▼

PIN ASSIGNMENTS

- 0. none
- 1. **Enable energy storage system**
- 2. none
- 3. none
- 4. none
- 5. none
- 6. none
- 7. none
- 8. none
- 9. none

■ can be used as an input or output
 ■ can be used as an input
 pin already in use

System monitoring settings

- Select "RESU7H / RESU10H" in the "Battery" field under Settings - System overview
- Select "activated" in the Meter field. The meter position must be selected under Settings depending on the installation (consumption branch or feed-in point)
- If the Checkbox has been installed correctly, check the box next to "Fronius Checkbox 500V installed"

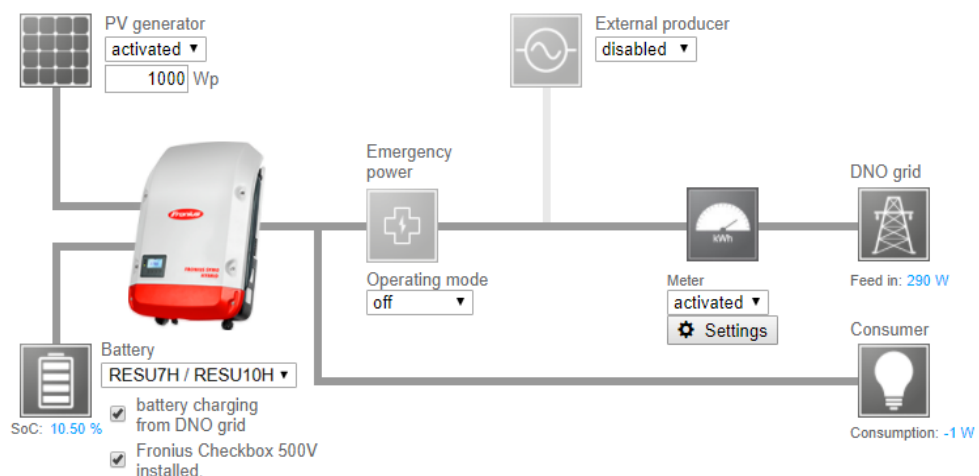

Troubleshooting

Troubleshooting	Battery is permanently in energy saving mode (error message 65000)
Behaviour	The battery goes into energy saving mode and can no longer be activated by the inverter
Remedy	Check if the DC main switch on the battery has been switched on
Remedy	Check if the DC main switch on the inverter has been switched on
Remedy	Check the cabling between the inverter, Checkbox and battery
Remedy	Restart the Datalogger (click the "Datalogger restart" button on the system monitoring website under "System information") - the ON LED on the battery goes green. When switching on, check that the green LED on the Checkbox also comes on.
Remedy	Using the display, place the inverter in standby mode for ten seconds - the ON LED on the battery will go green. When switching on, check that the green LED on the Checkbox also comes on.

Other Languages

Deutsch



English



Ceština



Italiano



Français



Español



Deutsch
English
Ceština
Italiano
Français
Español

www.fronius.com/QR-link/4204260303DE
www.fronius.com/QR-link/4204260303EN
www.fronius.com/QR-link/4204260303CS
www.fronius.com/QR-link/4204260303IT
www.fronius.com/QR-link/4204260303FR
www.fronius.com/QR-link/4204260303ES

Dansk



Svensk



Polski



Português



Magyar



Türk



Dansk
Svensk
Polski
Português
Magyar
Türk

www.fronius.com/QR-link/4204260303DA
www.fronius.com/QR-link/4204260303SV
www.fronius.com/QR-link/4204260303PL
www.fronius.com/QR-link/4204260303PB
www.fronius.com/QR-link/4204260303HU
www.fronius.com/QR-link/4204260303TR

Slovenský



Nederlands



ελληνικά



Român



Slovenský
Nederlands
ελληνικά
Român

www.fronius.com/QR-link/4204260303SK
www.fronius.com/QR-link/4204260303NL
www.fronius.com/QR-link/4204260303EL
www.fronius.com/QR-link/4204260303RO

Fronius Worldwide - www.fronius.com/addresses

Fronius International GmbH
4600 Wels, Froniusplatz 1, Austria
E-Mail: pv-sales@fronius.com
<http://www.fronius.com>

Fronius USA LLC Solar Electronics Division
6797 Fronius Drive, Portage, IN 46368
E-Mail: pv-us@fronius.com
<http://www.fronius-usa.com>

Under <http://www.fronius.com/addresses> you will find all addresses of our sales branches and partner firms!